



ENGLISH

Thank you very much for purchasing the Sigma EF-530 DG SUPER EO-TTL II Electronic Flash. This product is specifically developed for the Canon EOS series SLR cameras. Depending on the camera model, functions and operation may vary. Please read this instruction booklet carefully. To add to your enjoyment of photography, the flash has a variety of features. To make the most of all these features and to get the maximum performance and enjoyment from your flash, please read this instruction booklet together with your camera's instruction manual before using the flash, and also keep it handy for your future reference.

PRECAUTIONS

In order to avoid causing any damage or injury, please read this instruction manual very carefully, paying attention to the cautionary signs below, before using the flash. Please take special note of the two cautionary signs below.





 **Warning !!** Using the product disregarding this warning sign might cause serious injury or other dangerous results.

 **Caution!!** Using the product disregarding this caution sign might cause injury or damage.







 Symbol denotes the important points, where warning and caution are required.

 Symbol contains information regarding the actions that must be avoided.

Warning !!

-  This flash contains high voltage circuits. To avoid electric shock or burns, do not attempt to disassemble the flash. If the outside shell of the unit is broken or cracked, do not touch the mechanism inside.
-  Do not fire the flash close to eyes. Otherwise the bright light could damage the eyes. Keep at least 1m/3feet distance between face and the flash unit when taking a picture with flash.
-  Do not touch the synchro terminal of your camera when the flash is attached to the hot shoe. High voltage circuitry could cause an electric shock.
-  Never use your camera in an environment where flammable, burnable, gas, liquids or chemicals, etc, exist. Otherwise it might cause fire or explosion.

Caution !!

-  Do not use this flash unit on any camera other than the Canon EOS series cameras, otherwise the flash may damage the circuitry of these cameras.
-  This flash unit is not waterproof. When using the flash and camera in the rain or snow or near water, keep it from getting wet. It is often impractical to repair internal electrical components damaged by water.
-  Never subject the flash and camera to shock, dust, high temperature or humidity. These factors might cause fire or malfunctioning of your equipment.
-  When the flash is subjected to sudden temperature change, as when the flash unit is brought from a cold exterior to warm interior, condensation might form inside. In such a case, place your equipment in a sealed plastic bag before such a change, and do not use the flash unit until it reaches room temperature.
-  Do not store your flash in a drawer or cupboard etc. containing naphthalene, camphor or other insecticides. These chemicals will have a negative effects on the flash unit.
-  Do not use a thinner, Benzene or other cleaning agents to remove dirt or finger prints from the component. Clean with a soft, moistened cloth.
-  For extended storage, choose a cool dry place, preferably with good ventilation. It is recommended that the flash be charged and fired several times a month, to maintain proper capacitor functioning.

DESCRIPTION OF THE PARTS

EXTERNAL PARTS

1.Flash Head 2.Built-in Wide Panel 3.AF Auxiliary Light 4.Bounce Angle; Up and Down
5.Bounce Angle; Right and Left 6.Bounce Lock and Release Button; Up and Down 7.Swivel Lock
and Release Button; Right and Left 8.LCD Panel 9.Battery Cover 10.Shoe Ring 11.Shoe

CONTROLS

12.MODE Button 13.<SEL> SELECT Button 14.< + > Increment Button 15.< - > Decrement Button
16.ZOOM Button 17.TEST Button 18.LIGHT Button 19.Ready Light 20.Power Switch

CAMERA MODELS AND FUNCTIONS

Although this Flash unit has been equipped with numerous functions, depending on the camera model being used some functions may have some limitations. Please confirm the type camera you have from the list below. Please refer to explanations of each function through the instruction manual; If no model information is specified, it means that this function of flash can be used with all type of EOS cameras.

A type camera	E-TTL(E-TTL II) Compatible EOS SLR cameras
B type camera	All other EOS cameras except those listed above

ABOUT THE BATTERY

This flash unit uses four “AA” type Alkaline dry cell batteries, Ni-Cad or Ni-MH rechargeable batteries. Manganese batteries can also be used but as they have a shorter life than Alkaline batteries, we do not recommend using them. Please replace batteries if it takes more than 30seconds to light the Ready Lamp.

To assure proper electrical contact, clean the battery terminals before installing the batteries.

NiCad batteries do not have standardized contacts. If you use NiCad batteries, please confirm that the battery contacts touch the battery compartment properly.

To prevent battery explosion, leakage or overheating, use four new AA batteries of the same type and brand. Do not mix the type or new and used batteries.

Do not disassemble or short-circuit the batteries, or expose them fire or water; they may explode. Do not recharge the batteries other than Ni-Cd or Ni-MH rechargeable batteries.

When the flash will not be used for an extended period of time, remove the batteries from the flash to avoid the possibility of damage from leakage.

Battery performance decreases at low temperatures. Keep batteries insulated when using the flash in cold weather.

As with any flash, it is recommended you carry spare batteries when on a long trip or when photographing outdoors in cold weather.

BATTERY LOADING

1. Be sure to set the Power Switch to the off position then slide the battery cover in the direction of the arrow to open.

2. Insert four AA size batteries into the battery chamber. Be sure the + and – ends of the batteries are aligned according to the diagram in the chamber.

3. Close the cover.

4. Slide the Power Switch to the ON position. After few seconds the Ready Lamp will light, indicating that the flash unit can be fired.

5. Please press the “Test Button” to be sure that the flash is working properly.

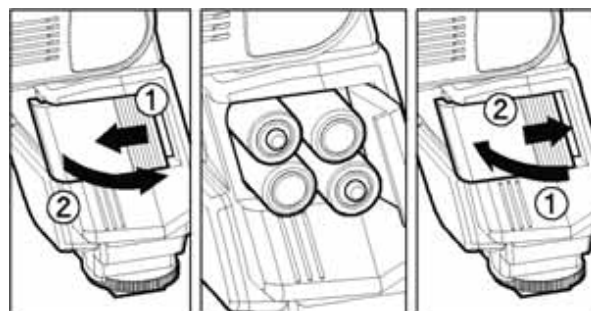

AUTO POWER OFF

To conserve battery power, the flash unit automatically turns itself off when the flash is not used within approximately 90 seconds. To turn the flash on again, depress the “TEST” button or the camera shutter button halfway. Please note that the “Auto Power Off” mechanism does not work with wireless TTL flash mode, normal slave flash, and designated slave flash modes.

ERROR INDICATION

If the battery power is not sufficient or there is an electric information error between the camera and flash unit, the “Flash Coverage Angle” will blink on the LCD panel. When this occurs, turn the power switch off and on.

If it still blinks after this procedure, check the battery power.

ADJUSTING THE FLASH HEAD

Depress the Bounce "Up and Down" Lock and Release Button and adjust the flash head to the desired position.

If  appears on the LCD panel when you turn on the flash, and if this mark blinks, then the flash head is adjusted to an incorrect position.

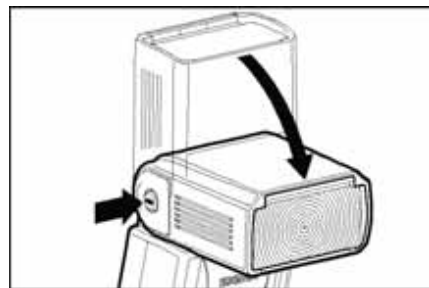

ATTACHING AND REMOVING THE FLASH TO AND FROM THE CAMERA

Be sure to turn off the Power Switch, then insert the Shoe Base into the hot shoe on the camera and turn the Shoe Locking Ring until it is tight.



When you attach or remove the flash, grasp the bottom of the flash to prevent damage to the shoe foot and the camera's hot shoe.

If the camera's built-in flash is set in up position, please close it before you attach the flash unit.

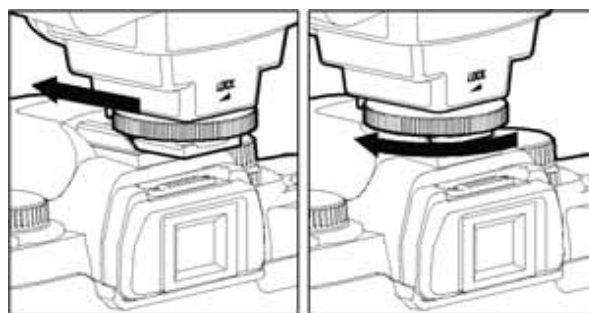
To remove the flash, rotate the shoe-locking ring in the opposite direction of  LOCK mark, until it stops.



SETTING OF FLASH COVERAGE ANGLE

When you press the  button, the  symbol appears. Each time you press the  button, the LCD panel display will change and indicate the zoom position in sequence as follows.

24mm 28mm 35mm 50mm 70mm 85mm 105mm (Auto)

Generally, in the ETTL (TTL) mode, the flash will automatically set the zoom position according to the focal length of your lens.

When you turn on the main switch, the flash will memorize and set the zoom head position to the last setting used.

If you use a lens wider than the flash head setting, there may be under exposed areas around the edge of the picture.

Depending on the flash head setting, the flash's Guide Number will be changed.



WIDE PANEL

This flash is equipped with a built in type wide panel, which can provide ultra wide 17mm angle of coverage. Slide out the wide panel and flip it down to cover flash's head. Then the coverage angle setting of the flash will be set to 17mm automatically.

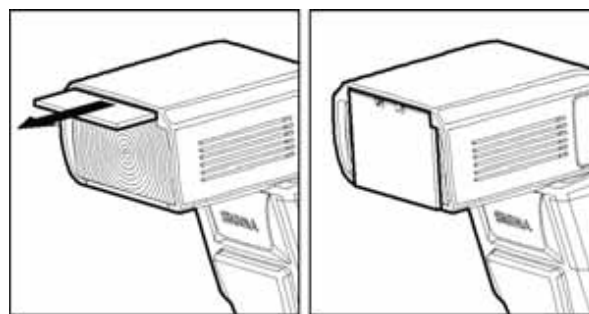
If the built-in wide panel comes off accidentally, the  button will not function. In this case please contact the store where the flash was purchased or a Sigma service station.





LCD PANEL ILLUMINATION

When you press the  button, the LCD panel will illuminate for about 8 seconds. The illumination stays on longer than 8 seconds if you press the  button once again.

ETTL (TTL) AUTO FLASH

In the TTL AUTO Mode, the camera will control the amount of flash lighting to get the appropriate exposure for the subject.

"A" type cameras can be set in ETTL mode. "B" type cameras can be set in TTL mode.

1. Set the camera's mode to Full-AUTO Mode. (Usually  Mode. If the camera does not have  Mode, set to P Mode.)

2. Turn on the power switch of the flash, the ETTL (TTL) mark will appear on the LCD panel and the flash will start charging.
3. Focus on your subject.
4. Check that the subject is located within the effective distance range indicated on the LCD panel.
5. Press the shutter button, after the flash is fully charged.

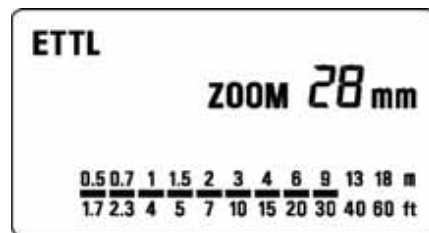

Note: When the flash is fully charged, the ready light in the viewfinder appears.

When the camera receives the appropriate exposure, the ETTL (TTL) mark on the LCD panel will appear for 5 seconds. If this indication does not appear, the flash illumination is not sufficient for that situation. Please re-take the picture at a closer distance.

The AF Auxiliary Light will turn on automatically as you focus on a dark area. Note: Effective distance is up to about 0.7 to 9 meters (2.3-29.5 feet).

When the camera is set to 'Creative Zone', the flash will be set to TTL / ETTL mode.

When the flash is fully charged, the flash mark will appear in the finder. If the shutter is released before the flash is fully charged, the camera will take the picture at a slow shutter speed with no flash.

USING FLASH IN OTHER CAMERA MODES (Except EOS700, 750, 850)

Shutter Speed Priority Setting

By selecting the Tv mode of the camera, you can set the shutter speed from 30sec. to 1/X sync speed. When you set the desired shutter speed, the camera will select the appropriate aperture value for the scene. If the subject is too light or too dark, the aperture value indicator will blink and show the limit values (maximum or minimum aperture). In such a case, the camera proceeds to take a flash photograph at the limit value. Thus, the main subject in the picture should be exposed correctly, but the background may become under or over exposed.

Aperture Priority Setting

By selecting the Av mode of your camera, the camera will select the appropriate shutter speed for the scene. If the subject is too bright or too dark, the shutter speed indicator will blink and show the limit (highest or slowest shutter speed) value. The highest shutter speed will be limited to the camera's normal flash synchronization speed. In such a case, the camera proceeds to take a flash photograph at the limit value. Thus, the main subject in a picture should be exposed correctly, but the background may become under or overexposed.

When used with M Mode

You can set the desired aperture value and shutter speed from 30 seconds to the camera's flash sync speed. If the camera's exposure requires more light to achieve correct exposure for the inputted values, the flashgun will provide sufficient light to give the correct exposure, within the working range of the flashgun.

LIMITS OF CONTINUOUS SHOOTING

To prevent overheating of the flashgun's circuitry, do not use your flash unit for at least 10 minutes after continuously firing the flash for the number of exposures shown in the table below.

Mode	Number of Flash Exposures
TTL, M(1/1, 1/2)	15 Continuous Flash Shots
M(1/4, 1/8)	20 Continuous Flash Shots
M(1/16-1/32)	40 Continuous Flash Shots
Multi	10 Cycle

MANUAL FLASH OPERATION

Manual flash is provided for shooting subjects when the correct exposure is difficult to obtain in the TTL mode. In the manual flash mode, you can set the flash power level from 1/1 (full) to 1/128 power in one step increments.

1. Set the camera's exposure mode to M.
2. Press the **MODE** button on the flash unit to select M.
3. The flash power output value blinks when you press the **SEL** button.
4. Press **+** or **-** button to set the desired flash power output.

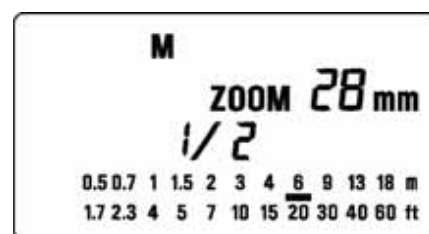

- The manual flash output display will stop blinking and remain displayed after you press the **SEL** button again.
- Adjust the focusing by pressing the shutter button, note the subject distance on the focus ring on the lens. Then adjust the lens' aperture value or flash power level until the distance indicated on the LCD panel of the flashgun is equal to the subject distance.
- When the Ready Light of the flash is illuminated, the unit is ready for use.

You can calculate the correct exposure by using the following formula:

$$\text{Guide Number "GN"} / \text{Flash to Subject Distance} = \text{F-stop}$$

This flash unit will automatically calculate and indicate the appropriate subject distance according to the above formula. (Please refer to table 1 on the last page)

SECOND CURTAIN SYNCHRONIZATION

When you photograph a moving subject with slow synchronization, usually the furrow of the subject will be exposed in front of the subject. The ordinary flash light will fire when the first shutter curtain is fully opened, thus the subject will be exposed from the time flash is fired to the time the shutter is closed (First curtain synchronization). When you use second curtain synchronization, the flash will fire just before the second curtain begins to close and the subject will be exposed by ambient light from the time the shutter opens until the flash fires. As a result the furrow of the subject will be recorded behind the subject. This is a more natural effect.

This mode cannot be used with EOS 700, 750, 850 cameras.

- Set the desired picture-taking mode of the camera.
- Press **+** or **-** button **▶** mark will be displayed on the LCD panel.
- Adjust the focus and take the picture after confirming the ready light.

First curtain synchronization will be set if **▶** mark is not displayed.

If the camera is set to Full Auto Mode this function cannot be used.

To cancel second curtain synchronization, turn off the **▶** mark on the LCD panel by using **+** or **-** buttons.

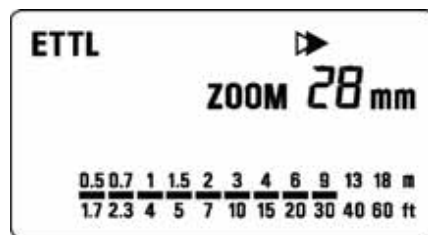

HIGH SPEED SYNC (FP) FLASH, A TYPE CAMERAS ONLY

When you take a picture with an ordinary flash, you cannot use a shutter speed faster than the camera's synchronized speed because the flash must fire when the shutter curtain is fully open. When using the High Speed Sync mode, the flash keeps firing while the shutter curtain is running, thus you can use a shutter speed faster than the shutter's normal synchronization speed.

- Select the camera's exposure mode. ("Tv" or "M" modes can be used)
- Select a shutter speed faster than the camera's normal synchronization speed.
- Slide the Power Switch of the flash to the ON position.
- Choose the Flash Mode by using **MODE** button ("ETTL" or "M" modes can be used).
- Press **+** or **-** button until the **FP** mark is displayed on the LCD panel.
- Focus on the subject
- Check that the subject is located within the effective distance, indicated on the LCD panel.
- Confirm the **⚡H** mark is in the viewfinder of the camera and then you can take the picture.

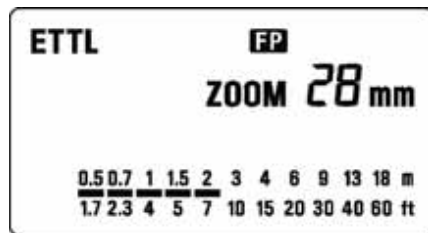

With high-speed sync, the Guide Number changes depending on the shutter speed. The flash range will be shorter (ie Guide Number will be smaller) when the shutter speed is faster. (Refer to table 2 on the last page). Selecting shutter speeds slower than the camera's normal synchronization speed cancels Hi-speed sync. Then the flash will automatically set to normal Ettl operation. To activate FP flash again, follow the procedure above from point 1.

It is possible to use the exposure compensation function with high speed synchronization operation. To do so, please refer to your camera's instruction manual regarding "exposure correction".

FP will disappear when Hi-speed sync (FP Flash) is cancelled.

FE LOCK

“FE” lock mode allows you to choose and lock the exposure before taking the picture.

1. Set the camera's exposure mode (“P”, “Tv”, “Av”, “M” or “DEP”).
2. Set the flash's mode to the E-TTL or the High Speed Sync.
3. Focus on the subject
4. Focus on the subject in the center AF frame of the viewfinder, and depress FE lock button.

The flash unit will make a pre-flash, then calculate and memorize the amount of light necessary for the correct exposure.

The camera's viewfinder will display “FEL” for 0.5 sec and the correct exposure will be set.

If the viewfinder shows  mark, it means that power is not sufficient for correct exposure. Please get closer to the subject and repeat from step 3.

5. After composing the picture, press the shutter button.

This function may vary depending on camera model. For more details please refer to “FE lock” instructions of your camera manual.

MODELING FLASH

If using the Modeling flash, you can check the lighting and shadow effects before taking the picture.

(This function is limited to cameras which are compatible with modeling flash. For more details, please refer to the instruction manual of your camera)

When the camera is set to modeling flash, the Flash panel will display the **MODEL** symbol automatically.

EXPOSURE COMPENSATION

You can use flash exposure compensation in combination with normal exposure compensation to control the background exposure level. Flash exposure compensation can be set to ± 3 stops in 1/3 stop increments (or in 1/2 stop increments with some cameras).

This mode cannot be used with EOS 620, 650, 700, 850 and 1000 cameras.

1. Press the **SEL** button and select .
2. Press the **+** or **-** button to set the desired flash exposure compensation amount.
3. Press the **SEL** button until the display stops blinking.
4. Focus on the subject.
5. Check that the subject is within the flash range as displayed on the EF 530 DG Super's LCD panel.
6. You can take the picture after confirming that the Ready Light of the flash is illuminated.

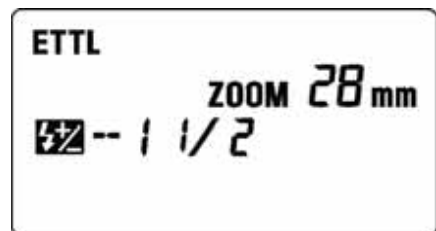

To cancel exposure compensation, please start from step 1 and choose + 0 on display.

FB (Flash Exposure Bracketing)

With FB, you can get bracketed flash shots of the subject while the ambient exposure level remains constant. The bracketed flash shots can be taken in the sequence of correct exposure, under exposure and over exposure, up to ± 3 stops in 1/3EV increments (or 1/2EV increments with some cameras).

1. Press the **SEL** button until **F b** blinks.
2. Press the **+** or **-** button to set the flash exposure bracketing amount.
3. **F b l** will be displayed after pressing the **SEL** button again.
4. Adjust the focusing.
5. Please check that the subject is within the flash range displayed on the EF- 530 DG Super's LCD panel.
6. Check the  mark is displayed in the viewfinder and take the picture.
7. If it is necessary, repeat steps 4 to 6.

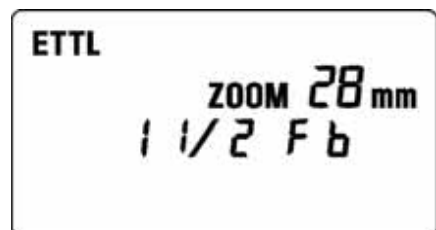

This function will be cancelled automatically after making the third exposure.

MULTI FLASH MODE

While the shutter is open, the flash will fire repeatedly. By doing so a series of images of the subject will be exposed in one frame. A bright subject with a dark background shows more effectively in this mode. It is possible to set the firing frequency between 1Hz and 199Hz. Up to 100 flashes can be fired continuously. The maximum number of flashes varies, depending on the flash's power output and firing frequency settings. (Please refer to table 3 on the last page).

This function cannot be used with EOS 700, 750, 850 cameras.

1. Set the camera's exposure mode to M mode and set the F number.
2. Press the **MODE** button until the Multi-flash mode appears.
3. Press the **SEL** button until the flash firing frequency starts to blink.
4. Press the **+** or **-** button to set the desired flash frequency value.
5. After pressing the **SEL** button again, the flash power level will blink.
6. Press the **+** or **-** button to set the desired power level.
7. Press the **SEL** button again, the number of flashes will blink.
8. Press the **+** or **-** button to set the desired number of flashes.
9. Press the **SEL** button again, the display will stop blinking.
10. When the ready light of the flash is illuminated, the unit is ready to use.

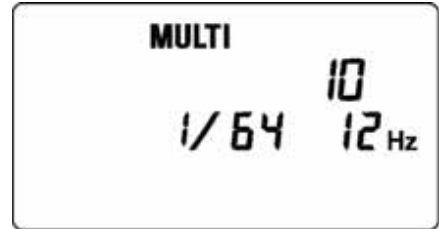

Note: Please set the shutter speed longer than; Number of Flashes you want ÷ Firing Frequency

BOUNCE FLASH

When you take a photo with flash in a room, sometimes a strong shadow will appear behind the subject, if you point the flash head upwards or sideways to reflect the light off the ceiling, wall etc. the subject will be illuminated softly. Press the lock button and adjust the flash head to set the bounce angle.

UP: 0°, 60°, 75°, 90° DOWN: 0°, 7°

RIGHT: 0°, 60°, 75°, 90° LEFT: 0°, 60°, 75°, 90°, 120°, 150°, 180°

When the bounce flash mode is activated, a bounce indicator  will appear on the LCD panel.

Choose a white surface for bouncing the flash, otherwise the image's colour may be incorrect.

Depending on the reflecting surface, the subject distance and other factors, the effective distance range for the TTL AUTO may change. Please check for correct exposure confirmation (ETTL or TTL mark on the LCD panel) after releasing the shutter.

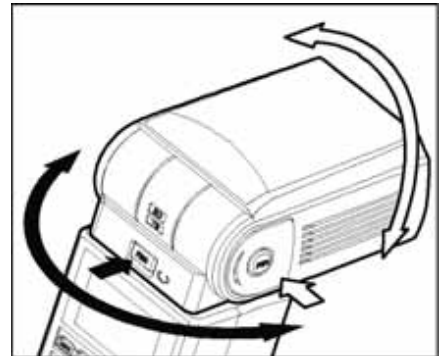

Close-up Exposures

Bounce flash can be tilted 7° downward for close-ups. The Flash will be effective only for the subjects 0.5 meter to 2 meters. When the flash head is tilted 7°,  will blink.

WIRELESS FLASH

When using the "Wireless Flash" mode, you can take pictures with a more three-dimensional feeling, or make natural images by using shadowing depending on the flash position. This can be done without any extension cord connecting the camera body and flash. In case of the EF-530 DG SUPER, communication between the camera body and the flash will be achieved by the light produced by the flash. In the "Wireless Flash" mode, the camera will calculate the correct exposure automatically.

The type A camera models can be used with "Wireless Manual Flash" and "Wireless Multi Flash" functions only. The EOS750 and EOS850 cannot be used with "Wireless Flash".

In this instruction we call the flash unit which is attached to the camera body the "Master unit" and we call a flash unit at a remote position a "Slave unit".

When setting a slave unit at the desired position, you can use the mini-stand provided. This mini-stand has a screw hole for a tripod.

Place the slave flash unit at the desired location. Do not place the slave unit within the picture area.

Set the flash unit within the range of 0.5m/1.5ft~5m/16ft from the subject and set the camera body within the range of 1m/3ft~5m/16ft from the subject.

Preparation for Wireless Flash

Channel Setting

When other people are using Wireless Flash mode near you, your flash may be connected with the other person's flash and your flash may fire. In this circumstance, please set a different channel for your flash from that of the other person's.

Channel setting for Master unit

1. Press the **MODE** button to Select the  mark.
2. Press the **SEL** button several times to make the channel indicator blink.
3. Press the **+** or **-** button to set the channel number. (C1 ~ C4)
4. Press the **SEL** button several times to stop the blinking.

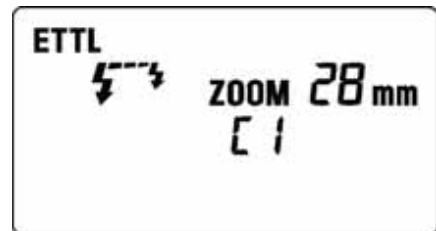

Channel setting for Slave unit

1. Press the **MODE** button to Select the ETTL /  / **SL** mark.
2. Press the **SEL** button several times to make the channel indicator blink.
3. Press the **+** or **-** button to set the channel to the same number. (C1 ~ C4) as the master unit.
4. Press the **SEL** button several times to stop the blinking.

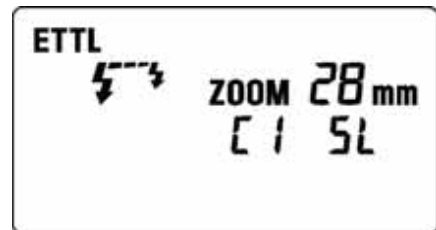

If the channel number of the Master and Slave flashguns are different, the Slave will not fire. Please set the same number for Master and Slave.

Slave Unit ID Setting

When you use several Slave units, the Slave ID can be set to distinguish a Slave unit from Main flash.

If you want to all Slave units to fire at the same flash output, this setting is not necessary.



1. Press the **MODE** button to Select the ETTL /  / **SL** mark.
2. Press the **SEL** button three times to make the Slave ID indicator blink.
3. Press the **+** or **-** button and set the ID number. (1, 2 or 3)
4. Press the **SEL** button again so the display stops blinking.

Repeat this process for each slave unit you are using, giving each one a different ID number.

Master Flash ON/OFF Setting



You can set the Master flash unit firing ON or OFF.

Master Flash unit firing ON

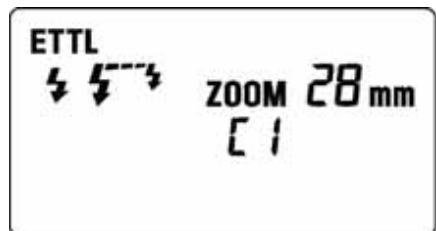
1. Press the **MODE** button to Select the  mark.
2. Press the **+** or **-** button to indicate the  mark.



Master Flash unit firing OFF

1. Press the **MODE** button to Select the  mark.
2. Press the **+** or **-** button to indicate the  mark.

Wireless ETTL Autoflash (type A cameras only)

In this Wireless ETTL Autoflash function, the camera automatically calculates the correct exposure.



Wireless ETTL Autoflash with Flash Ratio OFF

If you require an equal power ratio for each flash unit, the slave ID setting is not necessary. You can set 1, 2 or 3 for each Slave Unit in use.

All the Slave flash units will fire at the same flash output and the ETTL autoflash system controls the total flash amount automatically, to obtain a correct flash exposure.

The instructions below show how to reset the flashgun so no flash ratio is used and therefore equal power is emitted from each flashgun.

Please set the Master Flash unit as follows:

1. Press the **MODE** button to select the ETTL /  mark.
2. Press the **+** or **-** button to display the  mark (Master Flash will fire) or the shows  (Master Flash will not fire) in the LCD display.
3. Press the **SEL** button several times and confirm that the flash ratio is **1:1**.

- If the flash ratio is indicated as **12** or **123**, press the **+** or **-** button until **1:1** is displayed.
- Place the Slave Unit at the desired position.
 - Make sure that the Master Unit and Slave Unit have both been charged.
Master Unit's Ready Light is lit and Slave Unit's AF Auxiliary Light is blinking.
 - Focus on the subject and take the picture.

Slave ID, Wireless E TTL Autoflash With Flash Ratio (Two Slave Units)

The Wireless E TTL autoflash system, described as an example, consists of a master unit on the camera, which will not fire, and two slave units. When you set the flash ratio, the E TTL autoflash system then controls the total flash amount according to the flash ratio, to obtain a correct exposure.

Only EOS-1V, EOS-3 cameras can use this function.

The flash ratio can be set between 8 : 1 ~ 1 : 1 ~ 1 : 8.

Please set the Slave ID to 1 and 2 for each Slave unit.

Set the Master unit as follow.

- Please set the Master Flash unit firing mode to OFF (see Mater Flash ON / OFF setting).
 - Press the **MODE** button to Select the E TTL /  mark.
 - Press the **SEL** button several times to make the flash ratio indicator blink.
 - Press the **+** or **-** button and select **12**. (Blinking)
 - Press the **SEL** button to make flash ratio value blink.
 - Press the **+** or **-** button to set the flash ratio.
 - Press the **SEL** button to make the Flash Ratio indicator stop blinking.
 - Place the Slave Unit at the desired position.
 - Confirm that both the master and slave units are charged.
 - Focus on the subject and take the picture.
- If you want to change the settings, you can start from step 3.
If you want to cancel the setting, please set the flash ratio **1:1**. (refer to step 4)

Slave ID, Wireless E TTL Autoflash With Flash Ratio (Three Slave Units)

The following wireless E TTL autoflash procedure is for a master unit with three (3) slave units. This procedure sets the flash ratio for two Slave Units and the flash exposure compensation amount for other slave unit.



Only EOS-1V and EOS-3 camera can use this function.

Please set the Slave ID 1, 2 and 3 for each Slave unit (See Slave ID Setting).

Set the Master unit as follow.

- Please set the Master Flash unit firing mode to OFF (See Master Flash ON / OFF Settings).
 - Press the **MODE** button to Select the E TTL /  mark.
 - Press the **SEL** button several times to make the flash ratio indicator display blink.
 - Press the **+** or **-** button to select the **1 2 3**. (Blinking)
 - Press the **SEL** button to make the flash ratio value blink.
 - Press the **+** or **-** button to set the flash ratio.
 - Press the **SEL** button to make the flash exposure compensation display blink.
 - Press the **+** or **-** button and set the flash exposure compensation amount.
 - Press the **SEL** button to make the indicator stop blinking.
 - Place the Slave Units at the desired position.
 - Confirm that both the master and slave units are charged.
 - Focus on the subject and take the picture.
- If you want to change the settings or cancel the flash ratio settings, you can start from step 3.

Wireless High-Speed Sync (FP Flash)

- Please set the master flash to Wireless Flash mode. (Refer to Page 21)
- Press the **+** or **-** button to set to  / **FP** (Master Flash unit firing ON) or  / **FP** (Master Flash unit firing OFF).
- The remainder of the procedure for setting wireless high-speed sync, is the same as for normal high-speed sync.
It is not necessary to make any additional settings on the Slave units.

Wireless Flash Exposure Compensation

1. Please set master flash unit to the Wireless Flash Mode.
2. Press the **SEL** button to make  mark blink.
3. Press the **+** or **-** button to set the flash exposure compensation amount.
4. Press the **SEL** button several times to make exposure compensation indicator appear.

It is not necessary to make any additional setting on the Slave units.

You can also set the flash exposure compensation individually for each slave unit. (If using more than one slave, you will need to apply steps 2-4 to each slave unit.)

Wireless FE Lock

1. First please set the flashgun to Wireless Flash mode.
2. Focus on the subject and press the FEL button on the camera.
3. The procedure for setting wireless EF lock is the same as for normal FE lock.

It is not necessary to make any change to the settings on the Slave units.

Wireless Flash Exposure Bracketing (FB)

1. First set the flash to the Wireless Flash Mode.
2. On the Master Unit, press the **SEL** button several times to make the **F b** mark blink.
3. Press the **+** or **-** button and set the flash exposure compensation amount.
4. Press the **SEL** button several times to make the indicator stop blinking.
5. The remainder of procedure for setting wireless FB is the same as for normal FB.

It is not necessary to change any settings on the Slave units.

Changing the Wireless Mode

Please set the flash as follows.

1. Press the **MODE** button to select the ETTL /  mark.
2. Press and hold the **SEL** button more than 2 seconds to make the mode indicator blink.
3. Press the **MODE** button and select the ETTL, M, or MULTI mode.
4. Press the **SEL** button to make the mode of indicator stop blinking.

Wireless Manual Flash

You can manually set the slave unit's flash output, with the master unit. The flash output among the slave units can be uniform or varied. To determine the proper flash exposure, use a hand-held flash meter.

Wireless Manual Flash With Uniform Flash Output

Please set the Master flash unit as described below.







1. Please follow the procedure of **Changing the Wireless Mode** and set to the M /  mark.
2. Press the **SEL** button several times to make the flash output amount indicator blink.
3. Press the **+** button or **-** button to set the flash output amount.
4. Press the **SEL** button several times until the display stops blinking.

If the master flash unit ON function is set, the master unit will also fire, at the same flash output.

Wireless Manual Flash With Varied Flash Output

You can set a different flash output for each slave unit(s) (the following explains the procedure for using three slave flash units). Set the slave units to normal Wireless Flash mode.

Please set the master flash unit as follows.

1. Please follow the procedure for **Changing the Wireless Mode** and set to the M /  mark.
2. Press the **SEL** button several times to make the  mark blink.
3. Press the **+** or **-** button to select  indicator. (blinking)
4. Press the **SEL** button, making the flash output display and  blink.
5. Press the **+** or **-** button to set the flash output amount for ID 1.
6. Press the **SEL** button make the flash output display and  blink.
7. Press the **+** or **-** button to set the flash output amount for ID 2.
8. Press the **SEL** button make the flash output display and  blink.
9. Press the **+** or **-** button to set the flash output amount for ID 3.
10. Press the **SEL** button to make the indicator stop blinking.

If there are only two slave units, please select the **i2** indicator at step 3 (step 9 and step 10 should be omitted).

Wireless Multi Flash

Set the master flash unit as follows.

1. Follow the procedure for **Changing the Wireless Mode**, and set to the **MULTI /**  mark.
2. Press the **SEL** button to make the firing frequency display blink.
3. Press the **+** or **-** button to set the firing frequency.
4. Press the **SEL** button to make the flash output amount display blink.
5. Press the **+** or **-** button to set the flash output amount.
6. Press the **SEL** button to make the flash count display blink.
7. Press the **+** or **-** button to set the flash count.
8. Press the **SEL** button to make the display stop blinking.

The firing frequency and flash count will be the same for all slave units.

Slave Flash

When selecting this mode with the **MODE** button, make sure that the flash indicator mode (ETTL, M, MULTI) is not displayed.

Normal Slave Flash

Even if the EF-530 DG SUPER is not attached to the camera body, you can fire the flash by using the camera's built-in flash or another flash unit.

1. Attach the flash unit to the camera's hot shoe.
2. Set the camera's exposure mode to the desired mode. If you use A or M mode, also set the desired aperture value.
3. Turn on the flash unit and press the shutter button half way.

Now, the aperture value and film speed are automatically transmitted to the flash unit.

4. Remove the flash unit from the camera.
5. Press the **MODE** button and select the  / **SL** (Slave) mode.
6. Press the **SEL** button several times to make the flash output value indicator blink.
7. Press the **+** or **-** button to set the flash output amount.

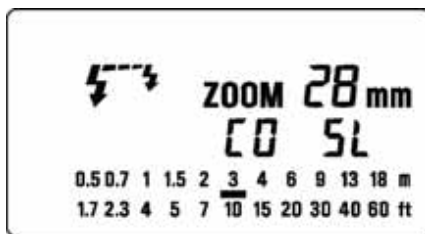

Determine the appropriate flash output by setting the distance indicator on the LCD panel to coincide as closely as possible with the actual distance from the slave flash to the subject. If the actual distance is out of range, you will need to change the aperture value or film speed.

- a. To change the aperture value: When the flash unit is set to the Slave mode, press the **SEL** button until the aperture value blinks, then press the **+** or **-** button to set the desired aperture value. Then press the **SEL** button to stop the display blinking.
 - b. To change the film speed: Press **MODE** to select the **ISO**, then press the **SEL** button to make the indicator for the aperture value blink. Press the **+** or **-** button and set the desired film speed, then press the **SEL** button once again. You will need to press the **MODE** button several times to return to the slave mode.
8. Press the **SEL** button several times to make the display stop blinking.
 9. Place the slave unit in the desired location. Do not place the slave unit within the picture area.
 10. After confirming that all flash units are fully charged, press the shutter button to take the picture.

When the EF-530 DG SUPER is fully charged, the AF Auxiliary Light will blink.

The flash will not fire if the EF-530 DG SUPER is attached to the camera body while it is in the Slave Mode setting.

If you are using a Canon brand flash unit with ETTL function on your camera and the EF-530 DG Super flash unit as a slave unit, please do not use the ETTL function, as the monitor pre-flash may cause the slave to fire prematurely.

Designated Slave Flash

If using two or more EF-530 DG Super flash units, you can designate which flash will fire together by using the channel settings. In this mode, one flash unit will be used as the Slave Controller and the others for firing as Slaves.

Setting the Slave Flash unit(s) for firing

1. Attach the slave unit to the camera body.
2. Set the camera's exposure mode to S or M.
3. Set the shutter speed to 1/30 or slower. (The slave controller unit (Master Flash) will transmit the designated signal before the others fire. Thus if you use a shutter speed faster than 1/30, the firing flash units will not be synchronized.)
4. Switch "ON" the flash unit and press the camera's shutter button halfway. (The aperture value and film speed are now automatically transmitted to the slave flash unit.)
5. Remove the slave flash unit from the camera.
6. Press the **MODE** button and select the **SL**. (Slave Mode)
7. Press the **SEL** button to make the channel display indicator blink.
8. Press the **+** or **-** button to set the channel number. (C1 or C2)
9. Press the **SEL** button to make the output amount display indicator of the flash blink.
10. Press the **+** or **-** button to set the flash output amount.
Set the flash power by setting the distance indicator on the LCD panel to coincide as closely as possible with the actual distance from the slave flash to the subject. If the actual distance is out of range, you need to change the aperture value.
11. Press the **SEL** button several times to make the display stop blinking.
12. Place the slave unit in the desired location. Do not place the slave unit within the picture area.

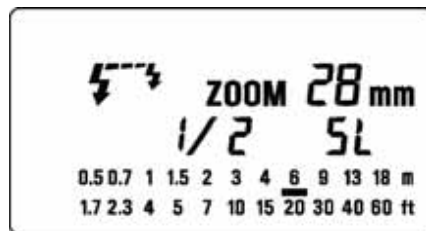

Setting for Slave Controller unit

13. Attach the Slave Controller flash unit to the camera body.
14. Press the **MODE** button and select the **SL**. (Slave Mode).
15. Press the **SEL** button to make the channel display indicator blink.
16. Press the **+** or **-** button to set the same channel number as that set on the firing flash unit.
17. Press the **SEL** button to make the flash output amount display indicator blink.
18. Press the **+** button so the **CEL** mark is displayed and blinking.
19. Press the **SEL** button twice to make the display stop blinking.
20. After confirming that all flash units are fully charged, press the shutter button to take the picture.
When the firing flash unit of EF-530 DG Super is fully charged, the AF Auxiliary Light will blink.
As the slave control using is in **CEL** mode, the aperture on the slave control unit can not be changed.
The Slave Controller unit functions only to control the slave unit.

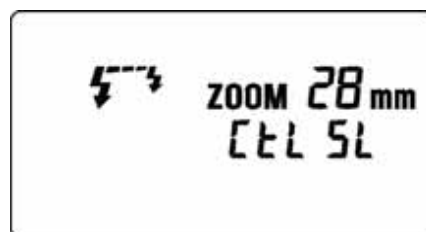

SPECIFICATIONS

TYPE : Clip-on type serial-controlled TTL auto zoom electric flash
GUIDE NUMBER : 53 (ISO 100/m, 105mm head position)
POWER SOURCE : Four AA type alkaline batteries or Four AA type Ni-Cd batteries or,
: Four AA type Ni-MH Nickel-Metal Hydride batteries
RECYCLING TIME : about 6.0 sec. (Alkaline batteries)
: about 4.0 sec. (Ni-Cd, Ni-MH Nickel-Metal Hydride)
NUMBER OF FLASHES : about 220 flashes (Alkaline batteries)
: about 100 flashes (Ni-Cd, Ni-MH Nickel-Metal Hydride)
FLASH DURATION : about 1 / 700 sec. (full power firing)
FLASH ILLUMINATE ANGLE : 24mm ~ 105mm motor powered control (17mm with Built-in Wide Panel)
AUTO POWER OFF : Available
WEIGHT : 335 g/11.8oz. DIMENSIONS : 77mm(W)/3.0in. x 139mm(H)/5.5in. x 117mm(L)/4.6in.